



First in Quality, First in Service.

---

# AIR DISTRIBUTION PRODUCTS

---

VOLUME 3

---



OSHAWA



Silencer Manufacturing: Woodbridge, Ontario

# TORONTO-MADE SILENCERS

SMWIA-L30 YELLOW LABEL MANUFACTURING

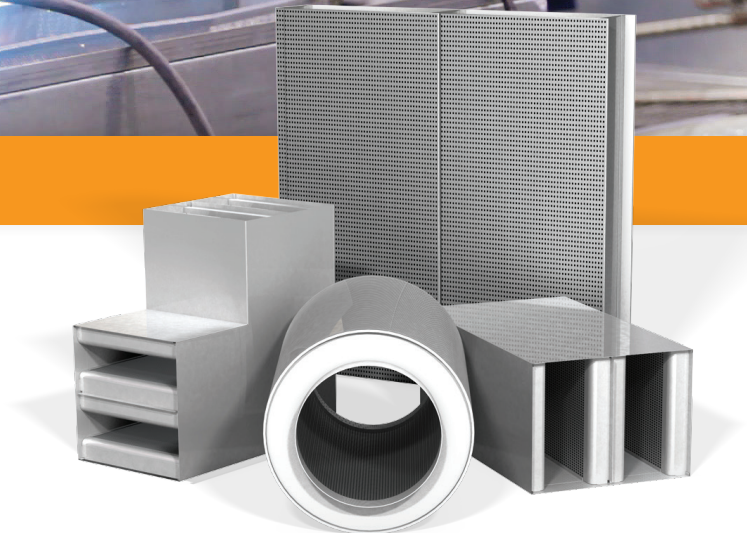

## PRICE SILENCERS

Price offers a full line of high quality noise control solutions for any HVAC and most light industrial systems.

- + Rectangular, elbow and circular silencers
- + Absorptive, film-lined, and packless
- + Speech privacy and cross talk silencers
- + Custom silencers
- + Acoustic enclosures
- + Acoustical louvers

## PRICE ACOUSTIC PANELS

Acoustic Panels are a highly effective method of controlling excessive equipment noise, and with tongue and groove construction, assembly is easy and installation time is minimized.

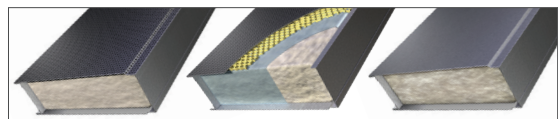

Standard Perforated/  
Solid Metal Panel

Perforated/Solid Metal  
Panel with Film Liner

Solid/Solid  
Metal Panel



Above: Chilled Beams

# ACTIVE & PASSIVE BEAMS



## BUILDING APPLICATIONS

- + Thermal comfort is a major design consideration
- + Spaces with high sensible heat releases
- + Spaces requiring high indoor air quality (100% fresh air)
- + Spaces requiring energy conservation

## AIR-WATER SYSTEM BENEFITS

- + Reduced system power consumption
- + Reduced maintenance costs
- + Environmental quality
  - Improved indoor air quality
  - Improved thermal comfort
- + Reduced mechanical footprint

## ACTIVE & PASSIVE BEAM TYPES

- + Active linear, vertical, horizontal, modular, perimeter induction units, exposed, and floor mounted cabinets
- + Passive linear beams
- + Passive beams with integrated return

# LABORATORY

## PRODUCT APPLICATION

### Supply Venturi Valves

- Medium (0.6 to 3.0 in.w.c.) or low (0.3 to 3.0 in.w.c.) pressure operation
- High-speed actuation
- Characterized and calibrated using NVLAP accredited test stations (Lab Code: 201067-0)
- Operating pressure feedback

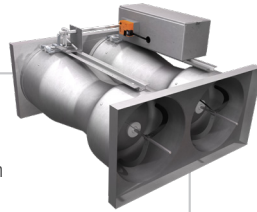

### Pace™

- Pressure or volumetric offset control strategies
- Airflow control utilizing Venturi Valves, Venturi FX Valves or Terminal Units
- High speed room level network for communication to Pace and FHC controllers
- BACnet MS/TP



### Integrated Reheat Coil

- Factory mounted transition
- Coil access door

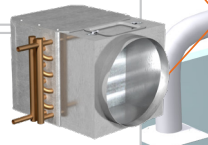

### Room Pressure Sensor

- Maintenance and calibration-free sensor technology
- Accurate to 3% of reading
- Designed to prevent buildup of airborne particulates



### Thermostat

- LCD or blank-face options
- Optional humidity or CO<sub>2</sub> sensing
- Optional connection to room level network for commissioning

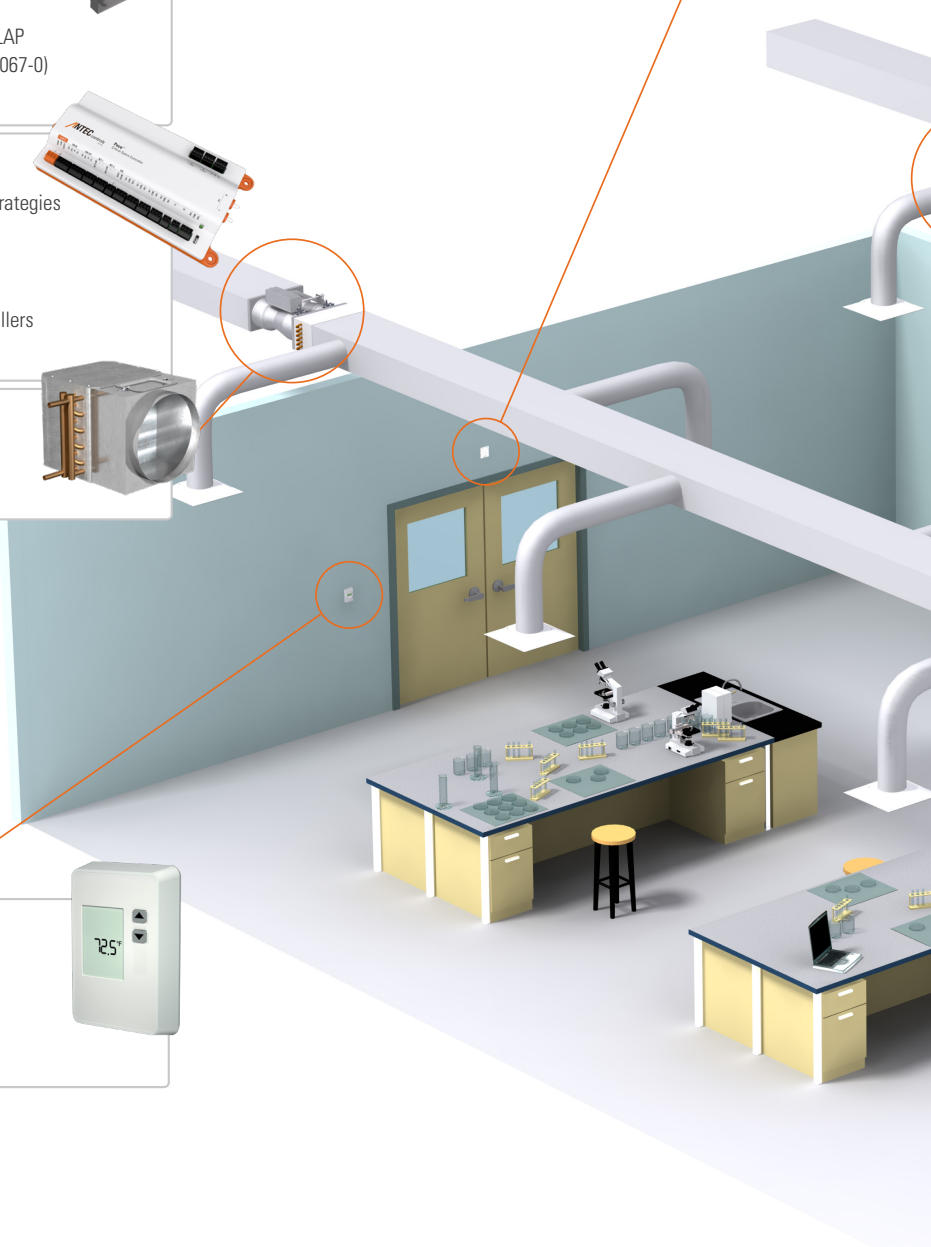

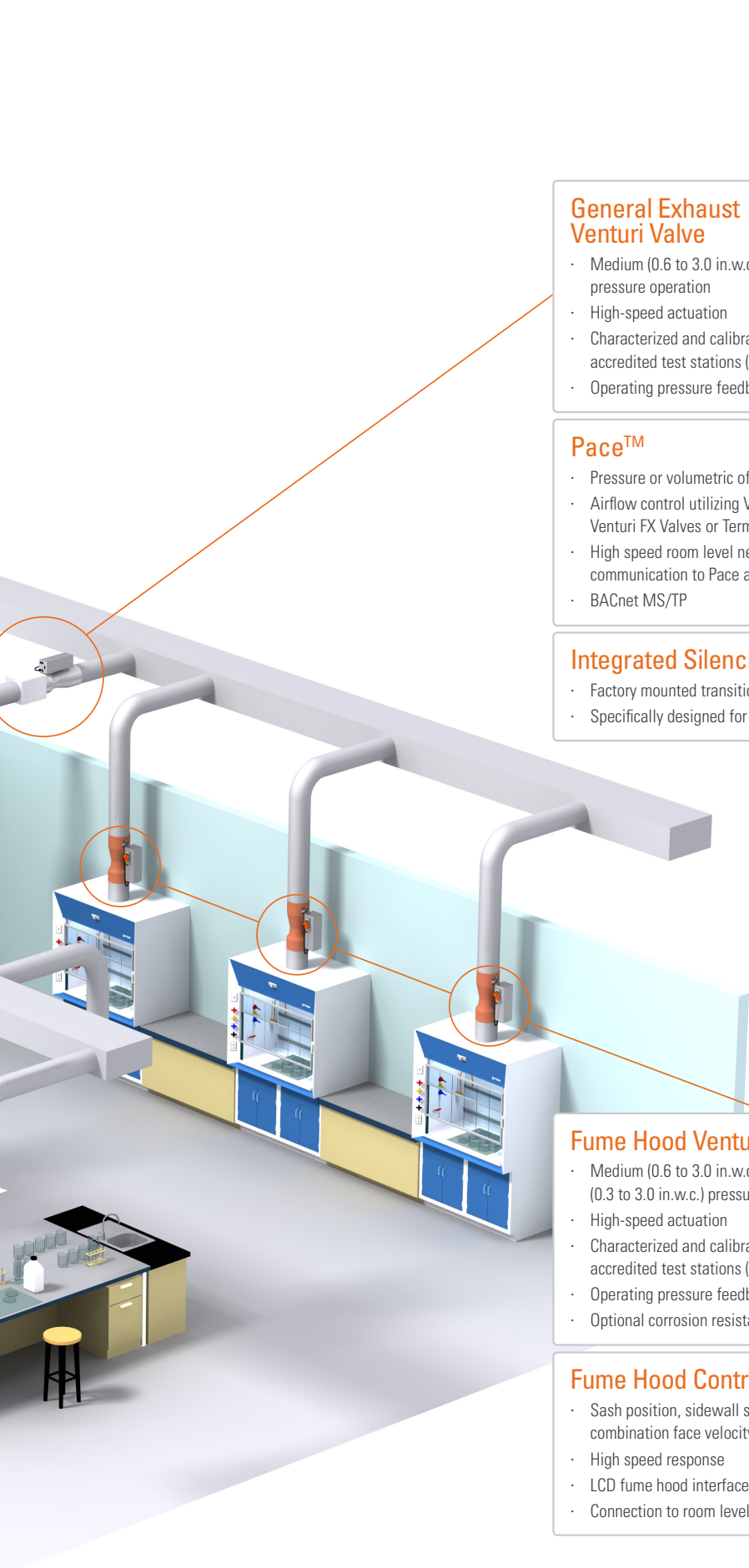

### General Exhaust Venturi Valve

- Medium (0.6 to 3.0 in.w.c.) or low (0.3 to 3.0 in.w.c.) pressure operation
- High-speed actuation
- Characterized and calibrated using NVLAP accredited test stations (Lab Code: 201067-0)
- Operating pressure feedback

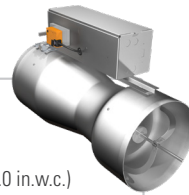

### Pace™

- Pressure or volumetric offset control strategies
- Airflow control utilizing Venturi Valves, Venturi FX Valves or Terminal Units
- High speed room level network for communication to Pace and FHC controllers
- BACnet MS/TP



### Integrated Silencer

- Factory mounted transition
- Specifically designed for Venturi Valves



### Fume Hood Venturi Valve

- Medium (0.6 to 3.0 in.w.c.) or low (0.3 to 3.0 in.w.c.) pressure operation
- High-speed actuation
- Characterized and calibrated using NVLAP accredited test stations (Lab Code: 201067-0)
- Operating pressure feedback
- Optional corrosion resistant coatings

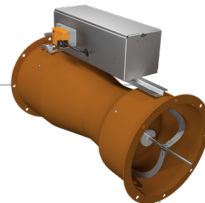

### Fume Hood Controller

- Sash position, sidewall sensor or combination face velocity control
- High speed response
- LCD fume hood interface
- Connection to room level network



## AIR PURIFICATION

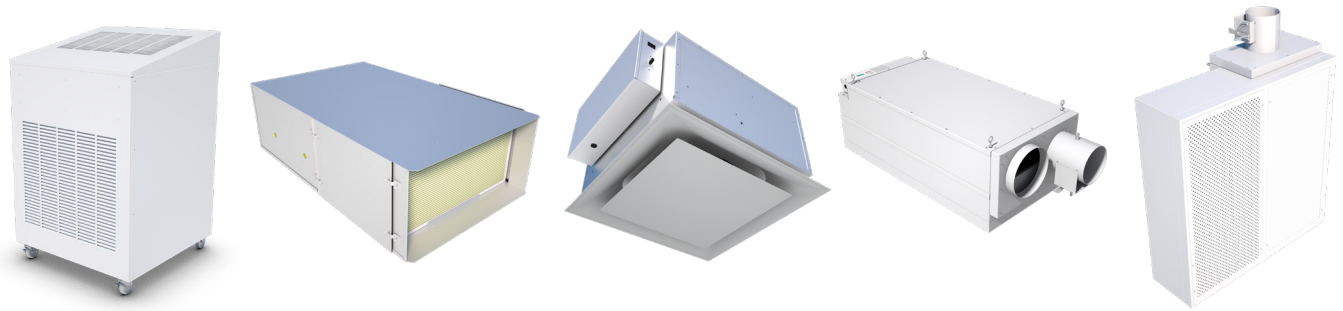

**price** | AIR PURIFICATION

Price Industries Limited  
[www.priceindustries.com](http://www.priceindustries.com)

### **RAP: Room Air Purifier**

- Rapid purification for high density areas
- UL 2998 and UL 867 certified
- Simple plug and play design
- Optional bipolar ionization and UV light treatment

### **OAP: Overhead Air Purifier**

- Premium installation flexibility
- Quiet air purification solution
- Ceiling mounted design to save valuable floor space
- Optional bipolar ionization and UV light treatment

### **CAP: Ceiling Air Purifier**

- Ceiling concealed with ultra quiet operation
- Motion sensor for maximum efficiency
- Smart Replacement Filter Indicator
- No modifications to existing HVAC system required

### **PURAFLO: Commercial Fan Filter Unit**

- Cleanroom-grade HEPA filtration
- Easy to install with no impact on existing HVAC
- Floor mount for immediate use or ceiling mount for permanent solution
- Dual-outlet reverse flow configuration able to increase air change rate and create negative room pressure

### **CARES: Critical Area Recirculation/Exhaust Systems**

- Part of the Pandemic-Ready Patient Room solution that converts a standard patient room to a negative pressure isolation room at the touch of a button
- Combines a reverse flow Fan Filter Unit (with HEPA) and a one-way, radial diffuser to manage airflow for an entire patient room

## GRILLES, REGISTERS & DIFFUSERS

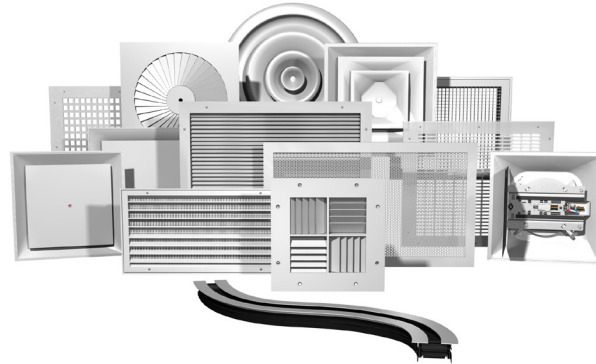

**price** | GRILLES

Price Industries Limited  
[www.priceindustries.com](http://www.priceindustries.com)

- Grilles and Registers
  - Standard Grilles and Registers
  - Linear Bar Grilles
  - Airfoil Series Grilles and Registers
  - Industrial / Special Application
- Filter Grilles
- Condo Grilles
- Nozzles
- Security Products
- Heavy Duty Gym Grilles



**price** | DIFFUSERS

Price Industries Limited  
[www.priceindustries.com](http://www.priceindustries.com)

- Linear Diffusers
  - Custom Flow Linear Diffusers
  - Linear Slot Diffusers
- Ceiling Component Diffusers
  - T-Bar Diffusers
  - Light Troffer Diffusers
  - Low Temperature Diffusers
- Ceiling Diffusers
  - Square Ceiling Diffusers
  - Perforated Ceiling Diffusers
  - Square and Rectangular Directional Diffusers
  - Round Cone Diffusers
  - VAV Diffusers



**price** | DISPLACEMENT

Price Industries Limited  
[www.priceindustries.com](http://www.priceindustries.com)

- Displacement Ventilation
  - Wall Mounted Displacement Diffusers
  - In-Wall Displacement Diffusers
  - Free Standing Displacement Diffusers
- Floor Mounted Displacement Diffusers
- Ceiling Mounted Displacement Diffusers
- Linear Enclosure Displacement Diffusers
- Industrial Displacement Diffusers

**price** | UNDERFLOOR  
**MODUFLEX**

Price Industries Limited  
[www.priceindustries.com](http://www.priceindustries.com)

- Underfloor Air Distribution
  - Round Floor Diffusers
  - Linear Floor Grilles
  - Linear Floor Heaters
  - Power and Control Modules
- Underfloor Terminal Units
- Underfloor Deflection Grilles
- Vertical Fan Column
- Linear Floor Plenums

## GRILLES, REGISTERS & DIFFUSERS CONT'D

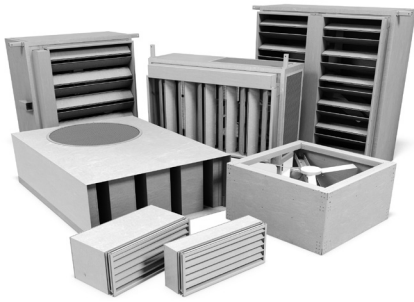

**Price Industries Limited**  
[www.priceindustries.com](http://www.priceindustries.com)

- Natural Ventilation
  - Natural Ventilation Roof Stack
  - Roof Mounted Natural Ventilation
- Natural Ventilation Terminal
- Wall Mounted Air Transfer Unit



**Acutherm**  
[www.acutherm.com](http://www.acutherm.com)

- Square VAV Diffusers
- Round VAV Diffusers
- Linear VAV Diffusers
- Pressure Control Products
- Temperature Control Products

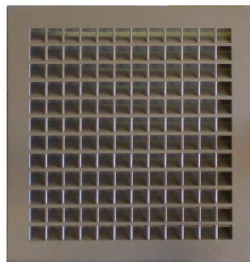

**Air Louvers Inc.**  
[www.activarcpg.com/air-louvers](http://www.activarcpg.com/air-louvers)

- Fire Rated Door Grilles



**Air Concepts Inc.**  
[www.airconceptsinc.com](http://www.airconceptsinc.com)

- Directional Air Distribution Products
- Punnah Diffusers
- Nozzle Diffusers
- Industrial Diffusers



**DuctSox**  
[www.ductsox.com](http://www.ductsox.com)

- Fabric Duct Ventilation
- Fabric Faced Diffusers
- Final Filters
- Underfloor Fabric Duct



# LOUVERS

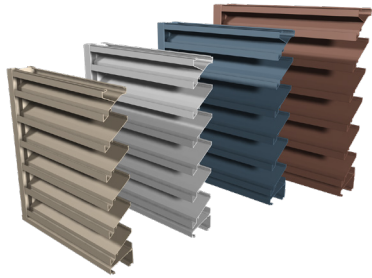

**Price Industries Limited**  
[www.priceindustries.com](http://www.priceindustries.com)

- Formed Metal Louvers
- Extruded Louvers
- Standard Blade and Chevron Blade Acoustical Louvers
- Extruded Penthouse Louvers
- Formed Metal Penthouse Louvers
- Thinline Wall Application Louvers
- Rain Storm Louvers
- Wind-Driven Rain Louvers
- Sand Louvers
- Vision Screens
- Sightproof Louvers
- Louvered Shapes
- Louvered Doors
- Sunshades
- Equipment Screens
- Architectural Louvers
- Special Louvers as per Request



**Air Louvers Inc.**  
[www.activarcpg.com/air-louvers](http://www.activarcpg.com/air-louvers)

- Door Louvers
  - Fire Rated
  - Non-Vision
  - Lightproof for Darkrooms and X-Ray Rooms
  - Adjustable
- Storm-Proof with Water Baffle
- Severe Windstorm Rated
- Security
- Vision Lites
- Fire-Rated and Impact-Rated Glass



**Greenheck**  
[www.greenheck.com](http://www.greenheck.com)

- Sightproof Extruded Louvers
- Wind-Driven Rain Resistant Extruded Louvers
- Extruded Louvers with Integral Motorized Dampers
- Sand Louvers
- Penthouses and Penthouse Elevator Vents
- Brick Vents
- Equipment Screens



**TAMCO**  
[www.tamco.ca](http://www.tamco.ca)

- Premium Quality Aluminum Louvers

## DAMPERS

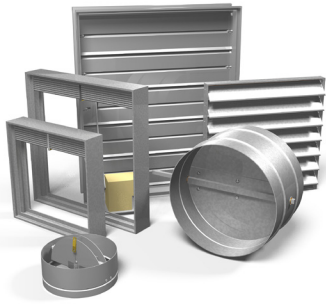

**Price Industries Limited**  
[www.priceindustries.com](http://www.priceindustries.com)

- Fire Dampers
- Smoke Dampers
- Fire / Smoke Dampers
- Ceiling Radiation Dampers
- Backdraft Dampers
- Control and Balancing Dampers
- Actuators
- Access Doors



**TAMCO Innovative Damper Products**  
[www.tamco.ca](http://www.tamco.ca)

- Premium Quality:
  - Thermally Insulated / Thermally Broken Frame Control Dampers
  - Aluminum Air-Foil Control Dampers
  - High Quality Aluminum Backdraft Dampers

## FANS

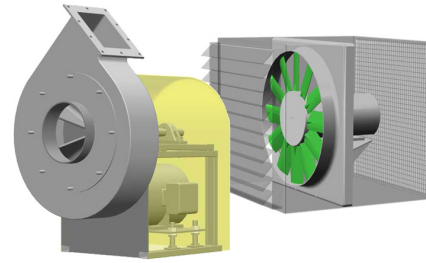

**Greenheck**  
[www.greenheck.com](http://www.greenheck.com)

- Fans
  - Centrifugal
  - Propeller
- Industrial Process Fans
  - Vane Axial
  - Mixed Flow
- Gravity Ventilators
- Energy Recovery Products
- Heat Recovery Products
- Indoor Air Handling Units
- Kitchen Ventilation Systems



**Universal Fan & Blower Ltd.**  
[www.universalfan.com](http://www.universalfan.com)

- Composite FRP / Corrosion Resistant
- Centrifugal and Axial Fans
- Wall Exhaust Fans
- Resistant Ductwork

FANS CONT'D



**Panasonic**

**Panasonic**  
[www.panasonic.com/building](http://www.panasonic.com/building)

- Advanced Ceiling Ventilation Fans
- Fan / Light Combinations
- Through-the-Wall Ventilation Fans
- Super Quiet Inline Fans



**Reversomatic**  
[www.reversomatic.com](http://www.reversomatic.com)

- Condominium Fans
- Commercial Fans and Range Hoods



**BROAN**

**Broan**  
[www.broan.ca](http://www.broan.ca)

- Kitchen Range Hoods, Exhaust Fans and Ventilators



**Plastec Ventilation, Inc.**  
[www.plastecvent.net](http://www.plastecvent.net)

- Corrosive Resistant Polypropylene Fans and Blowers
- Centrifugal Fans
- Inline Centrifugal Fans
- Stainless Steel Blowers



**Fantech**  
[www.fantech.net](http://www.fantech.net)

- Inline Duct Fans
- Bathroom / Kitchen Exhaust Fans
- Round Backdraft Dampers
- Lint Traps
- Heat Recovery Ventilators



**Envirofan**  
[www.envirofan.com](http://www.envirofan.com)

**Banvil 2000**  
[www.banvil2000.com](http://www.banvil2000.com)

- Ceiling Destratification Fans
- Industrial Ceiling Fans

## FANS CONT'D



Canarm/Delhi/Leaderfan  
[www.canarm.com](http://www.canarm.com)

- Industrial / Commercial Fans
- Industrial High Performance Ceiling Fans
- Wall Exhaust Fans and Circulating Fans
- Roof Exhausters
- Roof Supply
- Wall Supply / Air Make-Up
- Inline Duct Fan
- Wall Exhausters
- Circulating Fans
- Man Coolers



Big Ass Fans  
[www.bigassfans.com](http://www.bigassfans.com)

- Large Fans for Commercial and Industrial Applications
  - Summer Cooling
  - Winter Destratification / Heat Recirculation
  - High Volume, Low Speed Fans 8' to 24' in Diameter

## AIR FILTRATION – STANDARD & CRITICAL EXHAUST

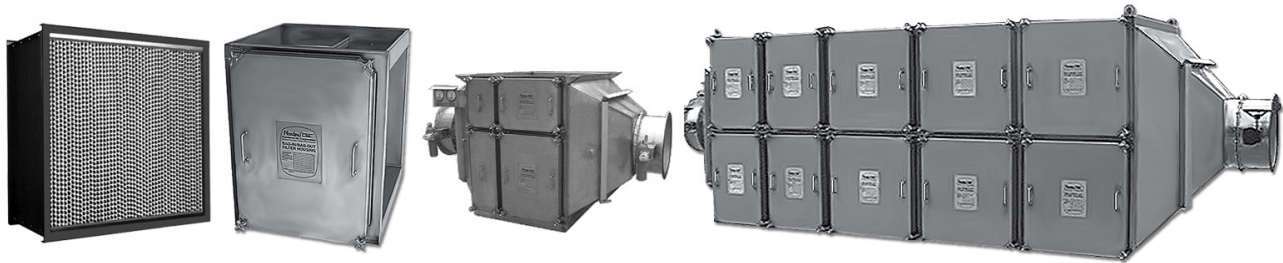

AAF Flanders  
[www.aafintl.com](http://www.aafintl.com)

- Disposable Air Filters
- Air Filter Media and Auto Rolls
- Pleated Filters
- Medium and High Efficiency Rigid Type Air Filters
- Medium and High Efficiency Extended Surface Type Bag Filters
- Metal Washable Air and Grease Filters
- Odor Control Filters
- Carbon Absorbers
- 95% DOP and HEPA / ULPA Filters
- HEPA Housings and Holding Frames
- ASHRAE Side Access Housings and Holding Frames
- Cleanroom Ceiling Filters and Hoods
- Gaseous / Vapor Phase Sideload and Front Load Housings
- CSC Containment Air Filtration Systems (Bag-In / Bag-Out)

## LABORATORY, CRITICAL ENVIRONMENT & SPECIALIZED EXHAUST PRODUCTS



Price Industries Limited  
[www.priceindustries.com](http://www.priceindustries.com)

- Ultrasuite O.R. System
- Common Plenum Lamina Array
- Hospital Grade Ceiling Systems
- Air Curtain Systems (HORD System)
- Fan Filter Units
- Laminar Flow Diffusers
- Radial Flow Diffusers
- Return and Exhaust Grilles
- Fume Hoods



Greenheck  
[www.greenheck.com](http://www.greenheck.com)

- Laboratory Exhaust Systems



Antec Controls  
[www.antecontrols.com](http://www.antecontrols.com)

- Valves
  - Venturi Valves – High Turndown Ratio and Mechanical Pressure Independence
  - Venturi FX – Measured Airflow and Low Pressure Operation
  - Integrated Venturi Valve Assembly Options
    - Performance Guaranteed Venturi with Integrated Silencer Assemblies
    - AHRI 410 Certified Venturi with Hot Water Coil Assemblies
    - UL1995 Certified Venturi with Electric Coil Assemblies
- Monitors and Controls
  - Room Monitors
    - Touchscreen Room Pressure Monitor – High Resolution Touchscreen Display
  - Multi-Variable Monitor – High Resolution Touchscreen Displaying up to 8 Rooms on Main Screen
  - All Monitors Have Native BACnet MS/TP Connection
  - Pace™ Critical Space Controller
    - Volumetric Offset or Pressure Control
    - Temperature and Humidity Control
  - Fume Hood Controls
    - Fume Hood Controller
      - Sash Position Sensing Fume Hood Control
      - Sidewall Sensing Fume Hood Control
      - Hybrid Fume Hood Control
    - Presence Sensing
    - Fume Hood Interface

## LABORATORY, CRITICAL ENVIRONMENT & SPECIALIZED EXHAUST PRODUCTS CONT'D

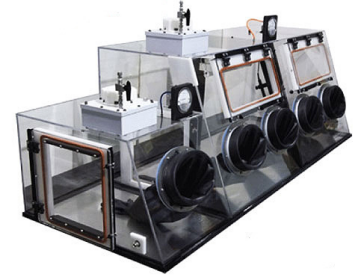
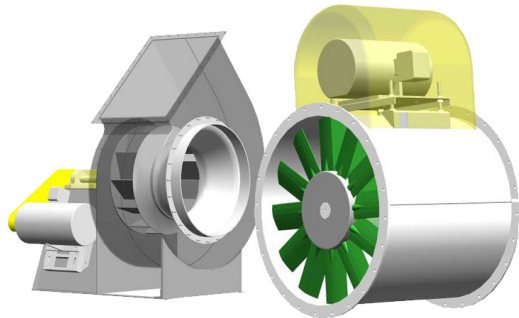

**Universal Fan & Blower Ltd.**  
[www.universalfan.com](http://www.universalfan.com)

- Composite FRP / Corrosion Resistant
- Centrifugal and Axial Fans
- Wall Exhaust Fans
- Resistant Ductwork



**Flow Sciences**  
[www.flowsciences.com](http://www.flowsciences.com)

- Containment Systems for Laboratory, Pilot Plant and Manufacturing Areas
- Specialists in Nanotechnology and Powder Containment
- Dedicated Engineers on Staff to Assist in Custom Equipment



**Nederman**

**Nederman**  
[www.nederman.com](http://www.nederman.com)

- Fume Extraction Arms and Fans
- Bench Top Flexible Extraction Arms and Fume Cabinets
- Filter Carts and Filter Box Mobile Fume Extractors
- Vehicle Exhaust Fume Extractors and Hose Reels
- Fume Extraction Rail Systems
- Electrostatic and Oil Mist Filters
- Magna Track Fire Station Exhaust Extractors for Rescue Vehicles



**Tjernlund Products, Inc.**  
[www.tjernlund.com](http://www.tjernlund.com)

- Side Wall Vent Systems
- In-Line Draft Inducers
- Ventilation Fans
- Duct Booster Fans
- In-Forcer Combustion Air Intake Systems
- In-Forcer Fresh Air Intake Systems
- Santek Electronic Air Cleaners
- Enviro-Tech Head Cooling Fans
- Variable and Fixed Speed Engineer Specified Systems
- Intelligent Exhaust and Ventilation Systems
- Constant Pressure Controller
- Modulating Draft System for Boilers and Water Heaters
- Modulating Combustion and Make-Up Air Systems
- Modulating Dryer Venting Systems

## ELECTRIC HEATING

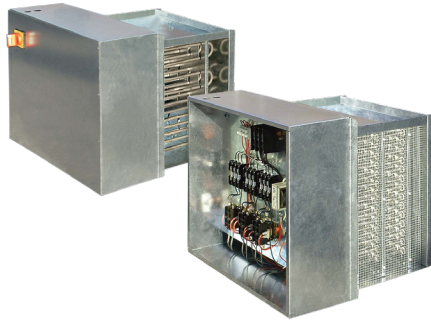

**Price Industries Limited**  
[www.priceindustries.com](http://www.priceindustries.com)

- Electric Duct Heaters
  - Open or Tubular Coils



**Neptronic**  
[www.neptronic.com](http://www.neptronic.com)

- Electric Heaters

## TERMINAL UNITS



**Ouellet Electric Heating**  
[www.ouellet.com](http://www.ouellet.com)

- Electrical Heating Products
  - Residential
  - Commercial
  - Industrial
  - Architectural
- Baseboard Heaters
- Unit Heaters
- Portable Heaters
- Draft Barriers
- Wall Heaters
- Diffuser Heaters
- Radiant Heaters
- Cabinet Convectors



**Price Industries Limited**  
[www.priceindustries.com](http://www.priceindustries.com)

- Single Duct Terminal Units
- Bypass Controller Type Terminal Unit
- Control Valves
- Dual Duct Terminal Units
- Fan Powered Terminal Units
- Induction Terminal Units
- Retrofit Terminal Units
- Special Application Terminal Units

## MAKE-UP AIR UNITS & AIR HANDLERS



**SolutionAir**  
[www.solutionairgroup.com](http://www.solutionairgroup.com)

- Air-Cooled DOAS Units
  - Up to 20,000 CFM
  - Heating Options: Gas, Electric, Steam and Hydronic
  - Cooling Options: Hydronic and DX (Packaged or Split)
  - Energy Recovery Options
- Customizable Air Handlers
  - Up to 100,000 CFM
  - Indoor / Outdoor Construction
  - Single / Double Wall Construction
  - Heating Options: Gas, Electric, Steam and Hydronic
  - Cooling Options: Hydronic and DX (Packaged or Split)
  - Energy Recovery
  - Packaged Control
- Make-Up Air Units
  - Direct Fired: 250 – 15,000 MBH
  - Indirect Fired Drum and Tube: 200 – 6,000 MBH
  - Indirect Fired Convolved Tube: 75 – 1,200 MBH
  - 90% Efficient Indirect Fired: 250 – 1,600 MBH
- Rooftop Units (8 – 250 Tons)
  - Highly Configurable
  - Heating Options: Indirect Gas, Electric, Steam and Hydronic
  - Cooling Options: Hydronic and DX (Packaged Up to 160 Tons and Split Up to 250 Tons)
  - Energy Recovery Options



**Greenheck**  
[www.greenheck.com](http://www.greenheck.com)

- Direct and Indirect Gas Fired Make-Up Air Units
- Indoor Air Handling Units
- Electric Heating, Hot Water, Chilled Water and DX Options

## GAS DETECTION



**Honeywell Analytics**  
[www.honeywellanalytics.com](http://www.honeywellanalytics.com)

- Commercial Gas Detection Systems
- Monitors, Controllers and Hand-Held Products



# Creating Safe & Clean Work Environments

- Fume Extraction Arms and Fans
- Bench Top Flexible Extraction Arms and Fume Cabinets
- Filter Carts & Filter Box Mobile Fume Extractors
- Vehicle Exhaust Fume Extractors and Hose Reels
- Fume Extraction Rail Systems
- Electrostatic & Oil Mist Filters
- Magna Track Fire Station Exhaust Extractors For Rescue Vehicles

**Nederman**

[www.nederman.com](http://www.nederman.com)



## KITCHEN VENTILATION SYSTEMS



**GREENHECK**  
Building Value in Air.

**Greenheck**  
[www.greenheck.com](http://www.greenheck.com)

- Wall, Island Proximity and Heat, Condensate Hoods
- Internal and External Supply Plenums Optional
- Standard Baffle Filter, High Velocity Cartridge, High Efficiency Grease-X-Tractor and Dual Stage Grease Grabber, Filtration
- FlexConnect Utility Distribution System
  - Factory Built Wall Utility Systems Offering Single Point Connections for Gas, Water and Electricity
- Easy to Clean Stainless Steel Exterior
- Adds Flexibility, Easy Relocation of Equipment, Reduces Installation Time, Allows Integration of Controls and Concealment of All Pipes and Wiring

First in Quality, First in Service

**e.h.price**

17

## FAN COILS & HYDRONIC HEATING AND COOLING

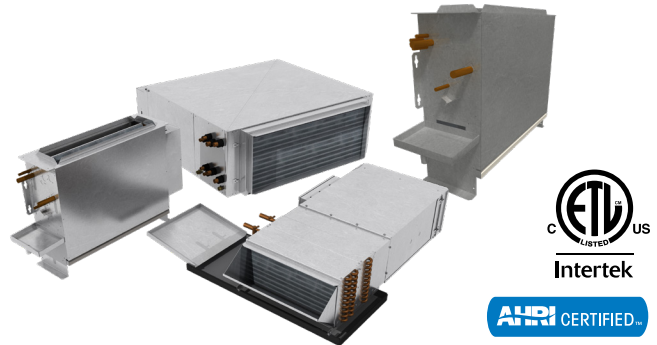

**Price Industries Limited**  
[www.priceindustries.com](http://www.priceindustries.com)

- Chilled Beams
  - Linear, Modular, Horizontal, Vertical and Floor-Mounted Active
  - Linear Passive
- Passive with Integrated Returns
- Controls and Hose Kits
- Retrofit Perimeter Induction Units



**Price Industries Limited**  
[www.priceindustries.com](http://www.priceindustries.com)

- High Performance Fan Coils
  - Optional Integrated Silencer
  - Standard ECM Motor
- Horizontal Blower Coils
- Vertical Fan Coils
  - Concealed and Exposed

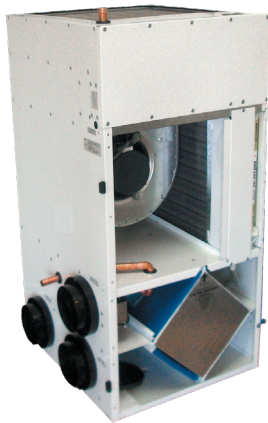

## HVAC DUCTING

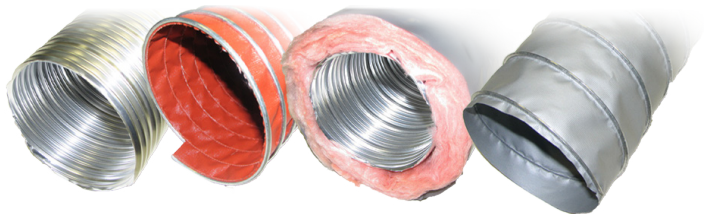

**Nu-Air Ventilation**  
[www.nu-airventilation.com](http://www.nu-airventilation.com)

- Enerboss Integrated Air Handlers and Fan Coils with Optional Integral HRV



**Peppertree Air Solutions**  
[www.peppertreeairsolutions.com](http://www.peppertreeairsolutions.com)

- Flexible HVAC Ducting

## NOISE CONTROL & VIBRATION ISOLATION

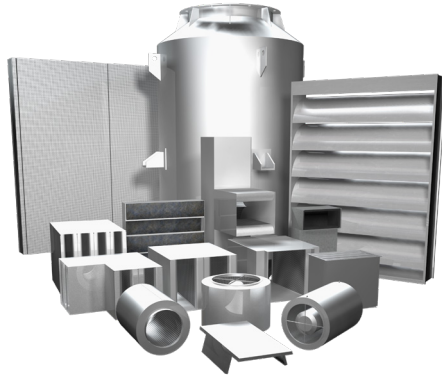

**Price Industries Limited**  
[www.priceindustries.com](http://www.priceindustries.com)

- Commercial and Custom Silencers
- Rectangular, Elbow and Circular Silencers
- Absorptive, Film-Lined and Packless Silencers
- Air Transfer and Cross-Talk Silencers
- Acoustic Panels, Enclosures and Barriers
- Acoustical Louvers
- SMWIA-L30 Yellow Label Manufacturing



**VMC GROUP**  
 THE POWER OF TOGETHER™

**The VMC Group**  
[www.thvmcgroup.com](http://www.thvmcgroup.com)

- Seismic Sway Bracing and Rod Stiffening Products
- Floor Mounted Seismically Restrained Isolators
- Seismic / Vibration Isolating Roof Curbs
- Spring Hangers
- Inertia Bases and Rails
- Flexible Connectors
- Piping Specialties
- Pad-Type Isolators

## AIR CURTAINS



**Biddle Climate Solutions**  
[www.biddle.ca](http://www.biddle.ca)

- Commercial, Retail and Industrial Air Curtains
- NOZ Adjustable Nozzle Unit Heater for High Induction

## HEAT & ENERGY RECOVERY



**SolutionAir**  
www.solutionairgroup.com

- RegenCore Alternating Mass-Exchanger Energy Recovery Units
  - No Pre-Heat Requirements Down to Outdoor Temperatures of -40°C
  - Up to 92% Effectiveness

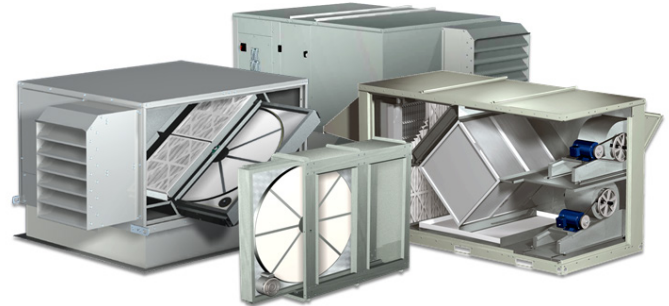

**Greenheck**  
www.greenheck.com

- Minivent Interior ERV
- PVE Plate Heat Exchanger
- ERV and ERVE Energy Recovery Units
- RVE Packaged Air Handler with Integral Energy Recovery

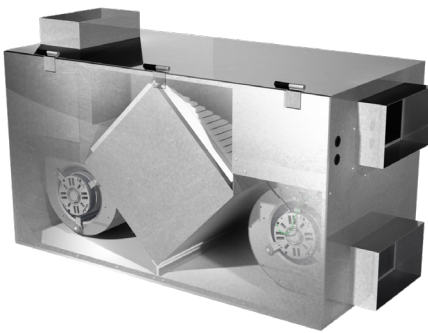

**Nu-Air Ventilation**  
www.nu-airventilation.com

- Residential HRVs and ERVs
- Commercial HRVs and ERVs
- Enerboss Integrated Air Handlers and Fan Coils
- Air Exchangers, Passive HRVs and Wet Basement Solutions
- Controls and Accessories



**Lifebreath**  
www.lifebreath.com

- Inline Fans
- Heat Recovery Ventilators
- Turbulent Flow Precipitators
- Clean Air Furnace

# CONTROLS



## price | CONTROLS

Price Industries Limited  
[www.priceindustries.com](http://www.priceindustries.com)

- Application Specific Controls For:
  - Networked or Stand-Alone Applications
  - VAV / VVT Controllers (BTL Certified)
  - Mini-Front-End Solutions
- Pneumatic Stand-Alone Controls
- Control Applications:
  - Rooftop Controls
  - Bypass Controls
  - Single Duct Controls
  - Fan Powered Controls
  - Prodigy Smart Diffusers
  - Web Server Graphical Interface
  - Hydronic Controls
  - Underfloor Controls



Franklin Control Systems  
[www.franklin-controls.com](http://www.franklin-controls.com)

- HVAC Specialty Products
  - Building Automation Starters
  - Standard Automation Starters
  - Cooling Tower Controls
  - Kitchen Hood Controls
  - Pump and HVAC Controls
  - Variable Frequency Drives (VFD)
- Industrial Products
  - Contactors and Overload Relays
  - Manual Motor Starters
  - Circuit Breakers
  - Starters
  - Soft Starters
  - Soft Starters with Integrated Bypass
  - Programmable Logic Controllers
  - Terminal Blocks
  - Pilot-Devices
  - Enclosures



# SMART STARTERS AND VFDs

Advanced Across the Line Solutions for HVAC Applications

## HVAC Specialty Products

- Building Automation Starters
- Standard Automation Starters
- Cooling Tower Controls
- Kitchen Hood Controls
- Pump & HVAC Controls



NEMA Rated  



## Industrial Products

- Contactors and Overload Relays
- Manual Motor Starters
- Circuit Breakers
- Starters
- Soft Starters
- Soft Starters with Integrated Bypass
- Programmable Logic Controllers
- Terminal Blocks
- Pilot-Devices
- Enclosures



[www.franklin-controls.com](http://www.franklin-controls.com)

# Experts in Gas Detection



- Commercial Gas Detection Systems
- Monitors, Controllers & Hand Held Products

**Honeywell**  
ANALYTICS

[www.honeywellanalytics.com](http://www.honeywellanalytics.com)

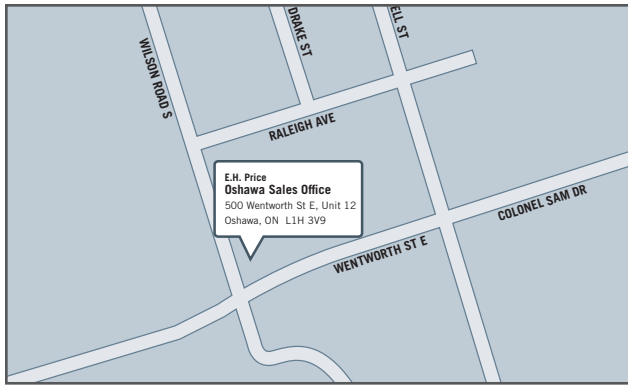

# e.h.price

**First in Quality, First in Service**

## E.H. PRICE OSHAWA

500 Wentworth Street East, Unit 12

Oshawa, ON L1H 3V9

Ph: 905.669.8988 Fax: 905.669.8023

Email: oshawa@ehpricesales.com

**Website: [www.ehpriceoshowa.com](http://www.ehpriceoshowa.com)**

**Local Delivery Available • Contact your E.H. Price Sales Representative for more information**

---

### LONDON

2351 Huron Street  
Unit #6  
London, Ontario  
N5V 3K4  
Ph: 519.451.5100  
Fax: 519.451.8726  
london@ehpricesales.com  
www.ehpricesouthwesternontario.com

### CAMBRIDGE

75 Saltsman Drive  
Unit #8  
Cambridge, Ontario  
N3H 4R7  
Ph: 519.653.9470  
Fax: 519.653.7853  
cambridge@ehpricesales.com  
www.ehpricesouthwesternontario.com

### HAMILTON

70 Unsworth Drive  
Unit #11  
Hamilton, Ontario  
L8W 3K4  
Ph: 905.383.3599  
Fax: 905.383.1274  
hamilton@ehpricesales.com  
www.ehpricehamilton.com

### TORONTO

571 Chrislea Road  
Unit #3  
Woodbridge, Ontario  
L4L 8A2  
Ph: 905.669.8988  
Fax: 905.669.8023  
toronto@ehpricesales.com  
www.ehpricetoronto.com

### OTTAWA

3236 Hawthorne Road  
Ottawa, Ontario  
K1G 3W9  
Ph: 613.725.2029  
ottawa@ehpricesales.com  
www.ehpriceottawa.com

### SUB REP - SUDBURY & N.E. ONTARIO

Jack Dougan Associates  
74 Mumford Drive  
Lively, Ontario  
P3Y 1H9  
Ph: 705.692.5838  
Fax: 705.692.5685  
www.jdaltd.ca

### SUB REP - WINDSOR

LK Metal Products Co. Limited  
1595 Lincoln Road  
Windsor, Ontario  
N8Y 2J3  
Ph: 519.256.1861  
Fax: 519.256.2828  
mail@lkmatal.com  
www.lkmatal.com